



FLANGE TOOL INNOVATION

PRODUCT DATA SHEET

SW15TE HYDRAULIC FLANGE SPREADER

MINI KIT | STANDARD KIT | MAXI-KIT

SPREADING FORCE:

with 700 bar (10 000 psi) hydraulic pressure applied:
15.5 T (155 kN) per tool

It is recommended that tools are used in pairs giving:
2 x 15.5 T = 31 T (310 kN)

TOOL WEIGHT = 7.0 kg (15.4 lb)

KIT COMPONENTS **MINI**

- 1 x SW15TE Wedgehead
- 1 x 700 bar (10 000 psi) Hydraulic Cylinder
- 1 x Safety Block
- 1 x Pair of Stepped Blocks
- 1 x Hex Key
- 1 x Instruction Manual
- 1 x Cardboard Packaging

Product Code: SW15TEMIN

KIT COMPONENTS **STD**

- 1 x SW15TE Wedgehead
- 1 x 700 bar (10 000 psi) Hydraulic Hose, 2 m (78.7")
- 1 x 700 bar (10 000 psi) Hydraulic Cylinder
- 1 x 700 bar (10 000 psi) HP350S Sealed Hand Pump with Gauge
- 1 x Safety Block
- 1 x Pair of Stepped Blocks
- 1 x Hex Key
- 1 x Instruction Manual
- 1 x Carry Case

Product Code: SW15TESTDSPB

KIT COMPONENTS **MAXI**

- 2 x SW15TE Wedgeheads
- 2 x 700 bar (10 000 psi) Hydraulic Hose, 2 m (78.7")
- 2 x 700 bar (10 000 psi) Hydraulic Cylinder
- 1 x 700 bar (10 000 psi) HP350D Sealed Hand Pump with Gauge
- 2 x Safety Blocks
- 2 x Pair of Stepped Blocks
- 2 x Hex Keys
- 1 x Instruction Manual
- 1 x Carry Case

Product Code: SW15TEMAXSPB

WEIGHTS AND DIMENSIONS

Tool weight: 7.0 kg (15.4 lb)
Safety Block: 0.5 kg (1.1 lb)
Gross weight: 7.5 kg (16.5 lb)

Tool weight: 7.0 kg (15.4 lb)
Carry-Case: 6.0 kg (13.2 lb)
Gross weight: 19.5 kg (43.0 lb)

Tool weight: 7.0 kg (15.4 lb)
Carry-Case: 6.0 kg (13.2 lb)
Gross weight: 31.0 kg (68.3 lb)

Packaging Dimensions:
190 mm x 180 mm x 320 mm
(7.5" x 7.1" x 12.6")

Carry-Case Dimensions:
920 mm x 520 mm x 210 mm
(36.2" x 20.5" x 8.3")

Carry-Case Dimensions:
920 mm x 520 mm x 210 mm
(36.2" x 20.5" x 8.3")

TOOL DIMENSIONS - CLOSED

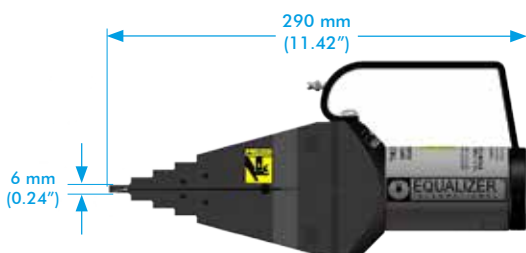

TOOL DIMENSIONS - OPEN

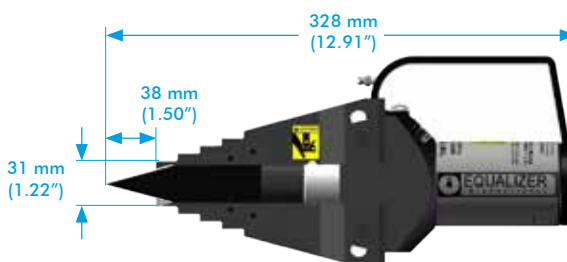

Hi-Press Hydraulics Ltd
Riverside Works,
Forge Road, Whaley Bridge,
High Peak, SK23 7HY
T: 01663 735089
Sales@hi-press.co.uk

Hi-Press Hydraulics Ltd
Unit 2, Hall House Ind Est,
New Hutton, Kendal,
Cumbria, LA8 0AH
T: 01539 734005
Cumbria@hi-press.co.uk

www.hi-press.co.uk

www.hi-press.co.uk/equalizer

SW15TE

HYDRAULIC FLANGE SPREADER



FLANGE TOOL INNOVATION

TOOL DIMENSIONS - CLOSED

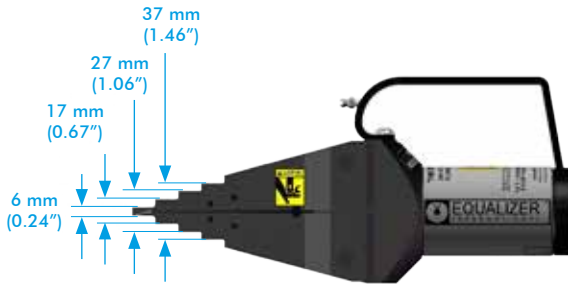

TOOL DIMENSIONS - OPEN

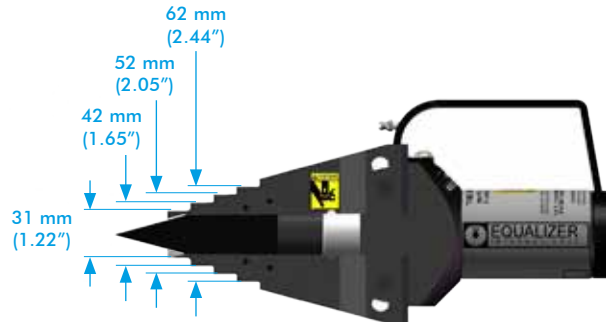

SAFETY BLOCK DIMENSIONS

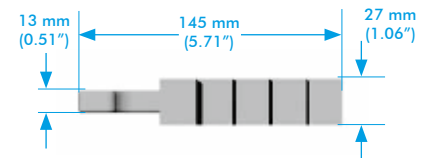
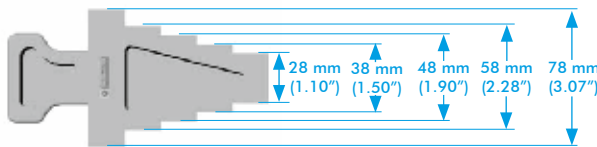

RANGE OF APPLICATION

All flanges with a minimum access gap of 6 mm (0.24")

| ITEM | DESCRIPTION | QTY. |
|------|---------------------------------------|-------------|
| 01 | SERIAL NO STICKER | 01 each |
| 02 | QC SEALED STICKER | 02 each |
| 03 | PINCH POINT STICKER | 02 each |
| 04 | GREASE POINT STICKER | 02 each |
| 05 | CYLINDER STICKER | 01 each |
| 06 | BADGE LOGO | 02 each |
| 07 | WEDGE | 01 each |
| 08 | PUSH PIN | 01 each |
| 09* | M5x6 SCKT SCREW | 01 set of 4 |
| 10* | SLIDE PIN | 01 set of 4 |
| 11 | HANDLE | 01 each |
| 12* | BASE SCREWS FOR HANDLE | 01 set of 2 |
| 13 | HYDRAULIC CYLINDER | 01 each |
| 14 | MAIN BODY (not replaceable) | 01 each |
| 15* | SPIROL PIN | 01 set of 8 |
| 16* | M6x12 GRUB SCREW | 01 each |
| 17 | M6 GREASE NIPPLE | 01 each |
| 18 | JAWS (PAIR) | 01 pair |
| 19* | RETAINING SCREW FOR HANDLE | 01 each |
| 20 | CYLINDER REPAIR KIT (Not Illustrated) | 01 kit |

*Items 9, 10, 12, 13 & 19 are supplied in Repair Kit Part No: 310301-01



STEPPED BLOCKS

Stepped Blocks can be used singly or in pairs to increase the maximum spreading distance of the SW15TE to 81 mm



WEIGHTS AND DIMENSIONS

Stepped Block: 0.52 kg (1.1 lb)
GROSS WEIGHT: 1.5 kg (3.3 lb)

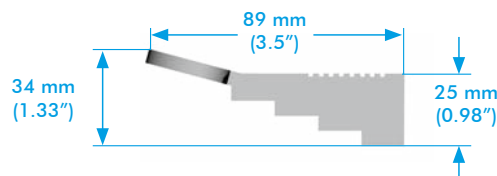

Hi-Press Hydraulics Ltd
Riverside Works,
Forge Road, Whaley Bridge,
High Peak, SK23 7HY
T: 01663 735089
Sales@hi-press.co.uk

Hi-Press Hydraulics Ltd
Unit 2, Hall House Ind Est,
New Hutton, Kendal,
Cumbria, LA8 0AH
T: 01539 734005
Cumbria@hi-press.co.uk

www.hi-press.co.uk

www.hi-press.co.uk/equalizer